

ISTRUZIONI DI MONTAGGIO

ASSEMBLY INSTRUCTIONS INSTRUCTIONS DE MONTAGE

INCLUSI NEGLI IMBALLI / INCLUDED IN THE PACKAGE ARE
INCLUS DANS LES EMBALLAGES

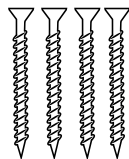

n°4 viti 4,5x60 mm
n°4 screws 4,5x60 mm
n°4 vis 4,5x60 mm



n°2 viti 3,5x20 mm
n°2 screws 3,5x20 mm
n°2 vis 3,5x20 mm



n°2 Rondelle
n°2 Washers
n°2 Rondelles



n°1 Trasverso
n°1 Transom
n°1 Traverse

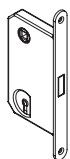

n°1 Serratura
Polaris
n°1 Polaris Lock
n°1 Serrure
Polaris



n°1 Incontro
+ vaschetta mag.
n°1 Counterplate
n°1 Gâche

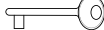

n°1 Chiave
n°1 Key
n°1 Clé

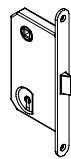

n°1 Serratura
Evolution mec.
n°1 Evolution
mechanic lock
n°1 Serrure
mécanique
Evolution



n°1 Contropiastra
meccanica
n°1 Mechanic
Counterplate
n°1 Mécanic
Gâche



n°1 Scrocco
n°1 Latch
n°1 Tirage



n°1 Mont. lato cerniere
n°1 Jamb hinges side
n°1 Chambranle côté charnières

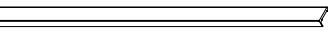

n°2,5 Copr. lato interno da 80 mm
n°2,5 Internal covering lists 80 mm
n°2,5 couvre-joints intérieurs 80 mm

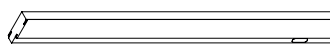

n°1 Mont. lato contropiastra
n°1 Jamb counterplate side
n°1 Chambranle côté gâche

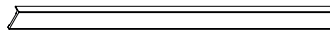

n°2,5 Copr. lato esterno da 80 mm
n°2,5 External covering lists 80 mm
n°2,5 Couvre-joints extérieurs 80 mm

Si raccomanda di seguire le istruzioni di montaggio e di evitare usi impropri.
Il prodotto teme il contatto diretto con l'acqua e gli ambienti molto umidi.
Per la manutenzione ordinaria, pulire il prodotto con panno umido o detersivi non aggressivi.
Per la manutenzione straordinaria, affidarsi a personale specializzato.
Per gli imballi è utilizzato materiale riciclabile al 100%.
Al termine dell'installazione tutti i materiali non utilizzati devono essere smaltiti in conformità alle norme vigenti e non dispersi nell'ambiente.
Il prodotto è conforme al D.L. N°206 del 06/09/2005 Codice al consumo.

*We recommend following the assembly instructions. Please avoid improper use.
Direct contact with water or very damp environments are to be avoided.
Everyday maintenance can be done with a soft cloth. Do not use aggressive cleaning substances.
For extraordinary maintenance you should ask specialized personnel.
Packaging used is 100% recyclable.
On completion of installation all unused materials must be disposed of in compliance with the current regulations and not dispersed in the environment.
The product is in line with D.L. No. 206 of 06/09/2005 Consumer Code.*

*Il est recommandé de suivre les instructions de montage et d'éviter toute utilisation inappropriée.
Le produit est sensible au contact direct avec de l'eau et à une forte humidité.
Pour l'entretien ordinaire, nettoyer le produit avec un chiffon humide ou des détergents non agressifs.
Pour un entretien extraordinaire, faites appel à du personnel spécialisé.
Pour l'emballage nous utilisons un matériau à 100% recyclable.
À la fin de l'installation, tous les matériaux non utilisés doivent être éliminés conformément aux réglementations en vigueur et ne pas être dispersés dans l'environnement.
Le produit est conforme à la D.L. N° 206 du 06/09/2005 Code de la consommation.*



EFFEBIQUATTRO Spa
Viale Edison 47
20831 Seregno (MB)
Tel. +39 0362.277.1
Fax +39 0362.277.777
info@effebiquattro.it
www.effebiquattro.it



EASY



EFFEBIQUATTRO *Milano*

www.effebiquattro.it

REVERSIBILITÀ / REVERSIBILITY / REVERSIBILITÉ

Apertura Sinistra
Left Opening
Ouverture à gauche

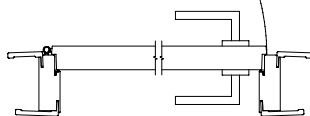

Apertura Destra
Right Opening
Ouverture à droite

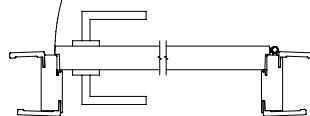

CONTRACT
EFFEBIQUATTRO

/ 1

/ REVERSIBILITÀ
APERTURA DA DX A SX

/ REVERSIBILITY
OPENING FROM RIGHT
TO LEFT

/ REVERSIBILITE'
DE DROITE À GAUCHE

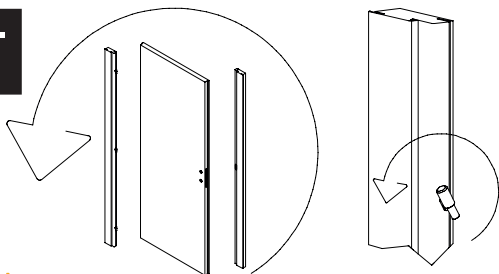

/ A

Ruotare le cerniere sul
montante
Turn the hinges on the jamb
Tourner les charnières du
chambranle

/ B

Ruotare le cerniere sull'anta
Turn the hinges on the panel
Tourner les charnières sur
le battant

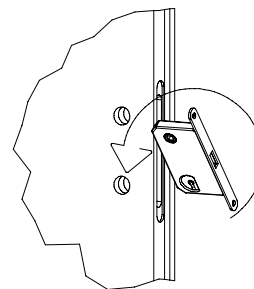

/ C

Svitare ed estrarre la serratura,
ruotarla e riavvitarla
Unscrew and take the lock out,
turn it and screw it again
DDévissez et sortez la serrure,
tournez-la et vissez-la

/ D

Inserire scrocco serratura
(nel caso sia presente la contropiastra meccanica)
Insert the latch into the lock
(when there is the mechanic counterplate)
Insérer le tirage dans la serrure
(Si Vous avez la gâche mécanique)

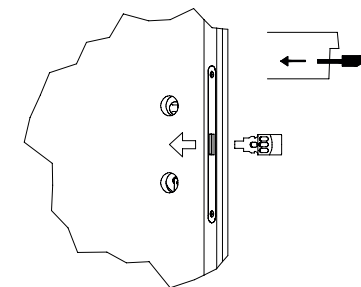

/ 2

Fissare la contropiastra

Fix the counterplate

Fixer la Gâche

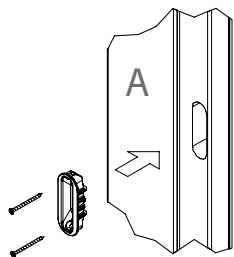

/ 3

Tagliare gli spigoli montante

Cut the jamb corners

Couper les bords des
chambranles

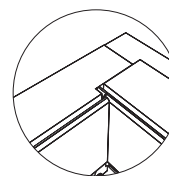

/ 4

Assemblare il telaio

Putting frame together

Assembler le cadre

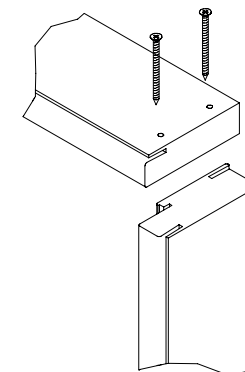

/ 5

Montare l'anta

Install the panel

Monter le battant

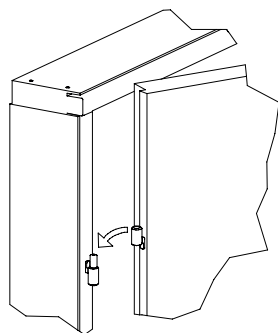

/ 6

Rifilare i coprifili interni
prima di inserirli nel vano e
fissarli

Trim the internal covering
lists before inserting them
into the compartment and
fixing them

Couper et fixer les
Couvrejoints intérieurs

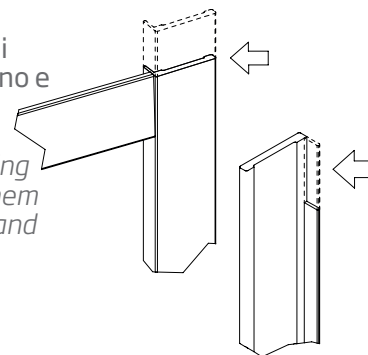

easy